

Osteoporosis Management Kit

Re-Alignment

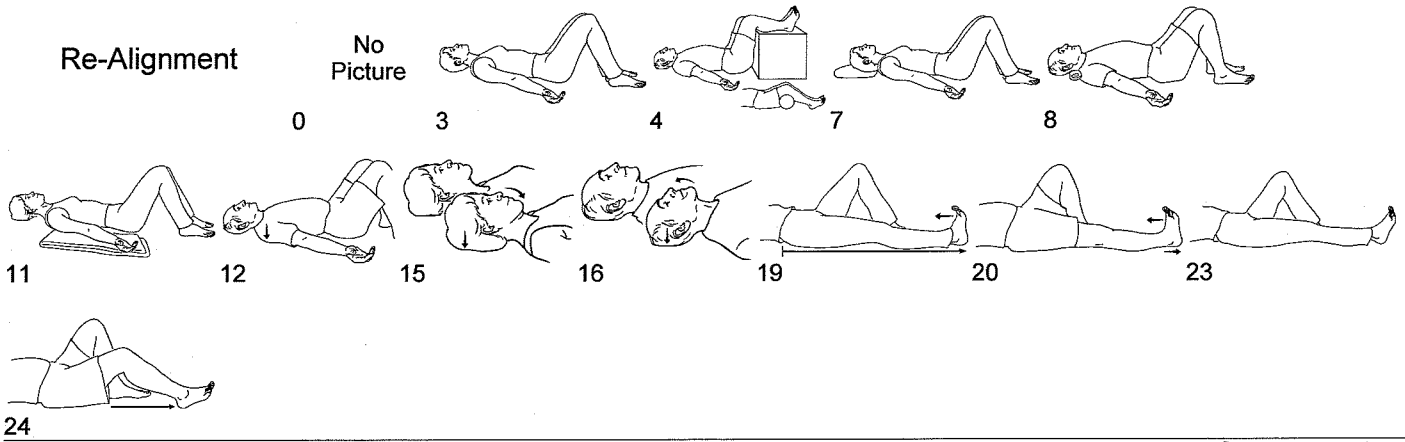

Postural Correction

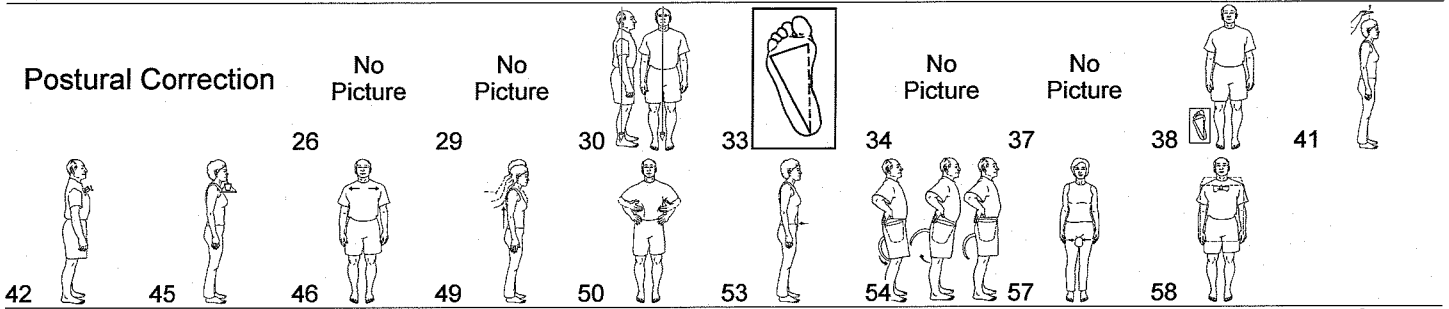

Breathing

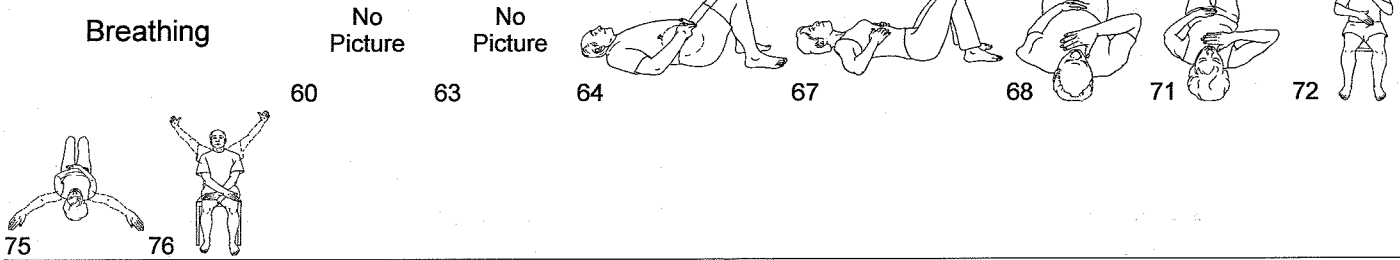

Standing Balance

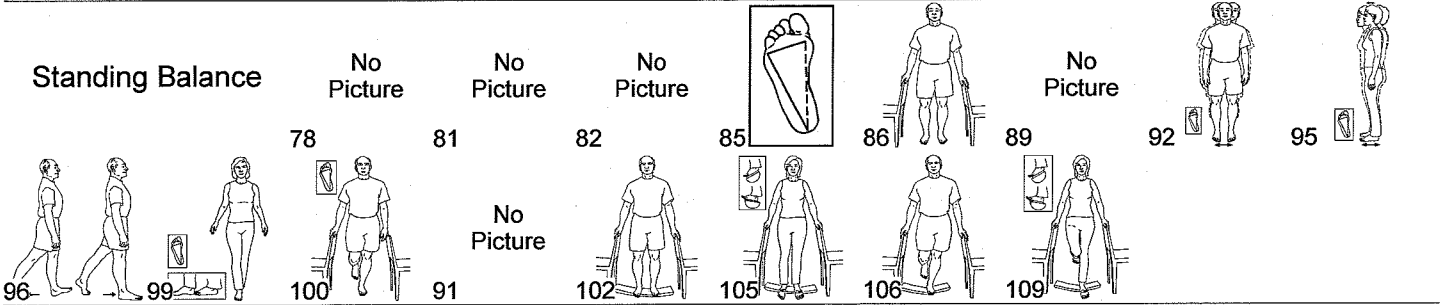

Walking

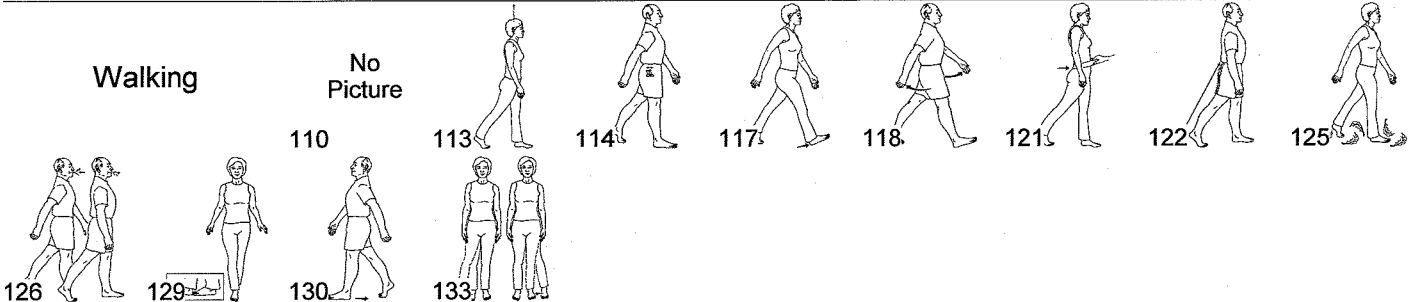

Supine

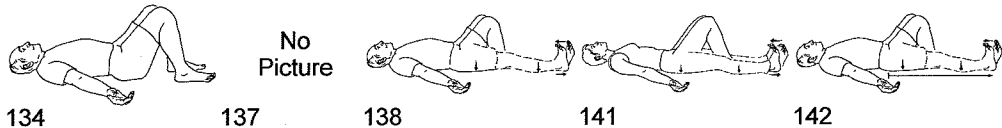

Osteoporosis Management Kit

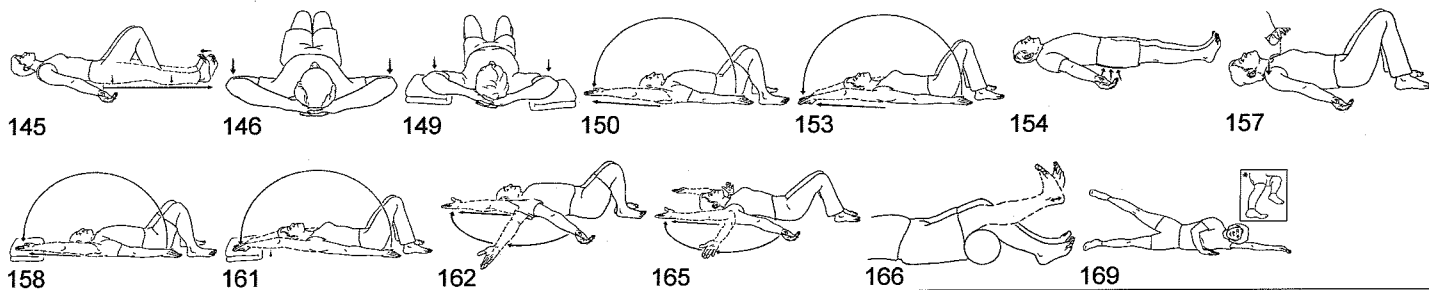

Prone

No Picture

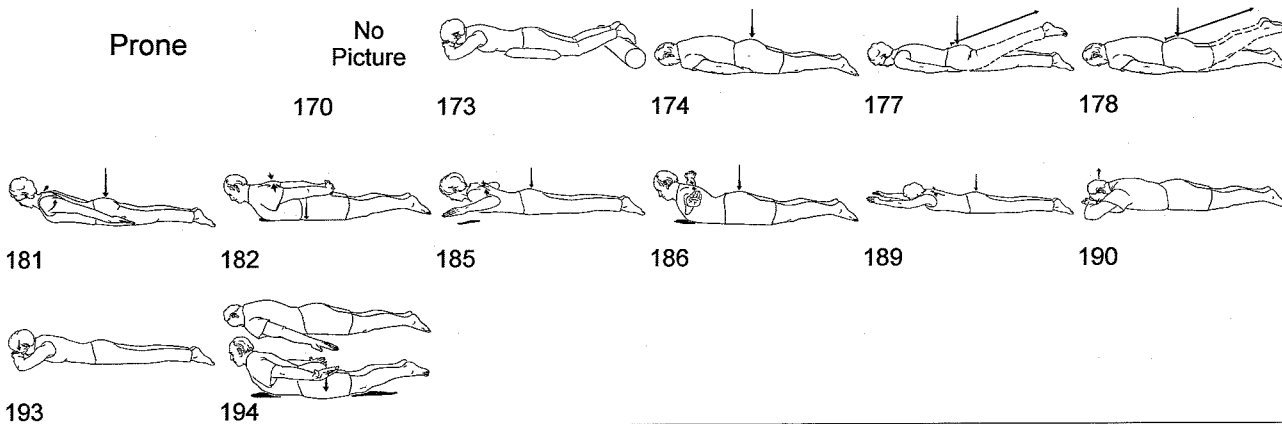

Standing

No Picture

No Picture

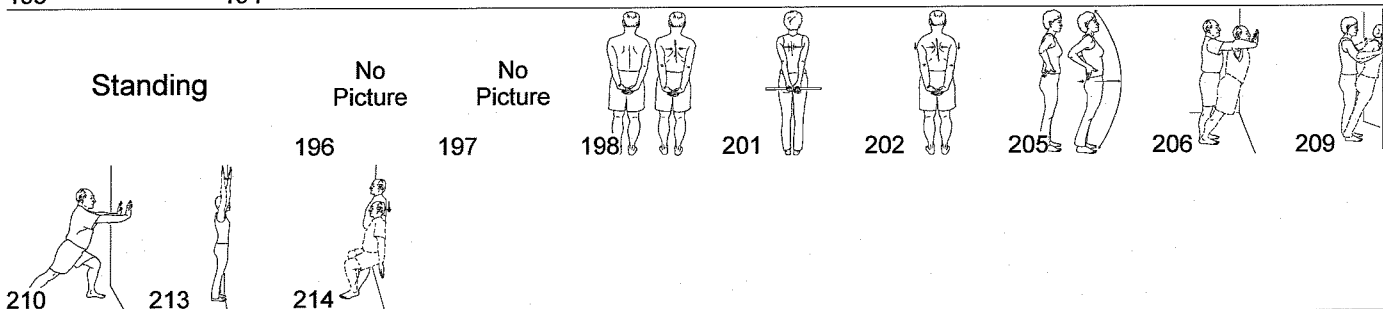

Resistance Band

No Picture

No Picture

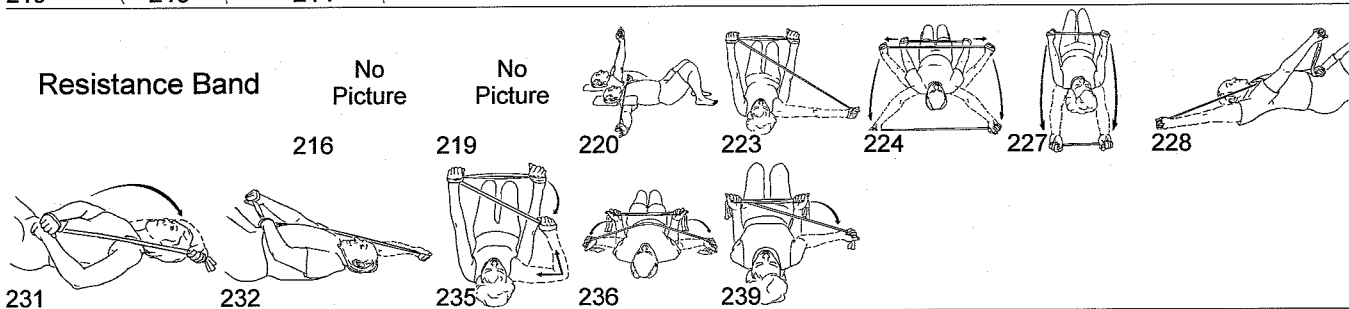

Weight Training

No Picture

No Picture

No Picture

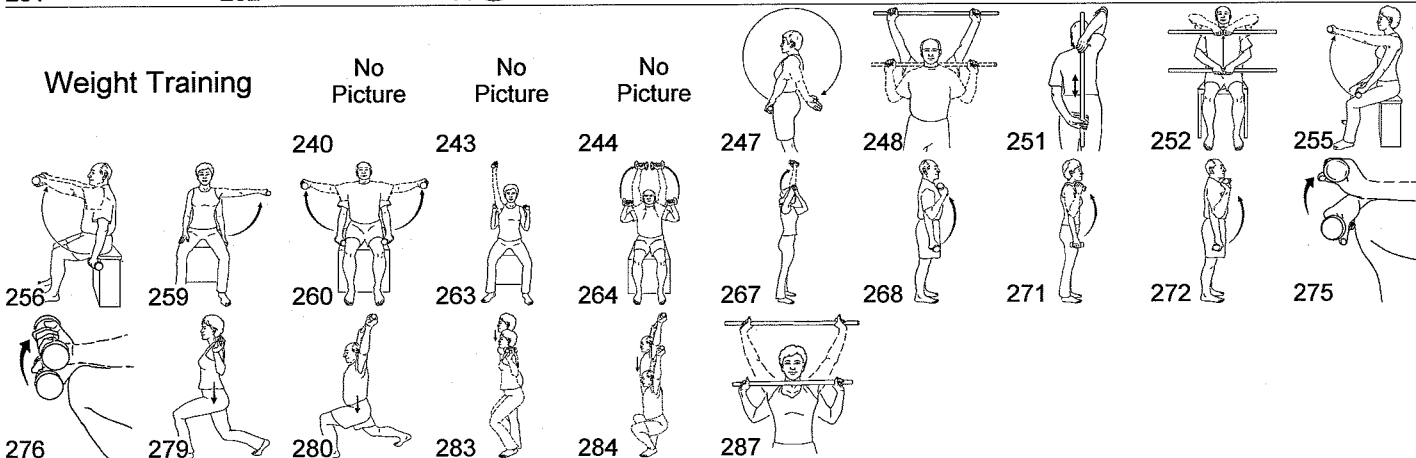

Osteoporosis Management Kit

Body Mechanics

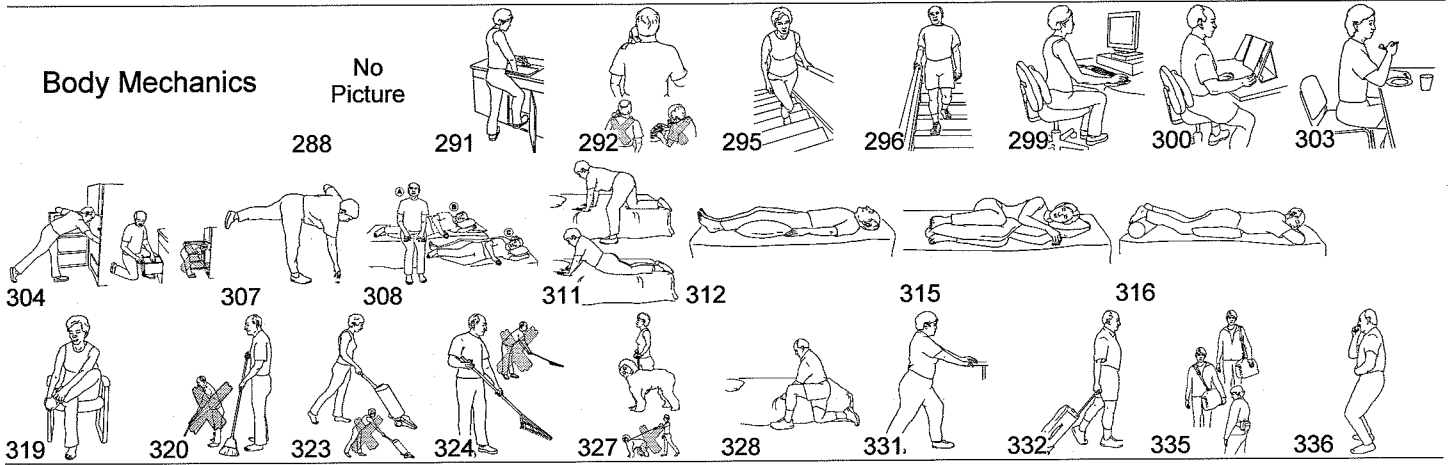

Leg Stretch With Strap

