

Neurological Rehabilitation Kit

ADL: Personal Care

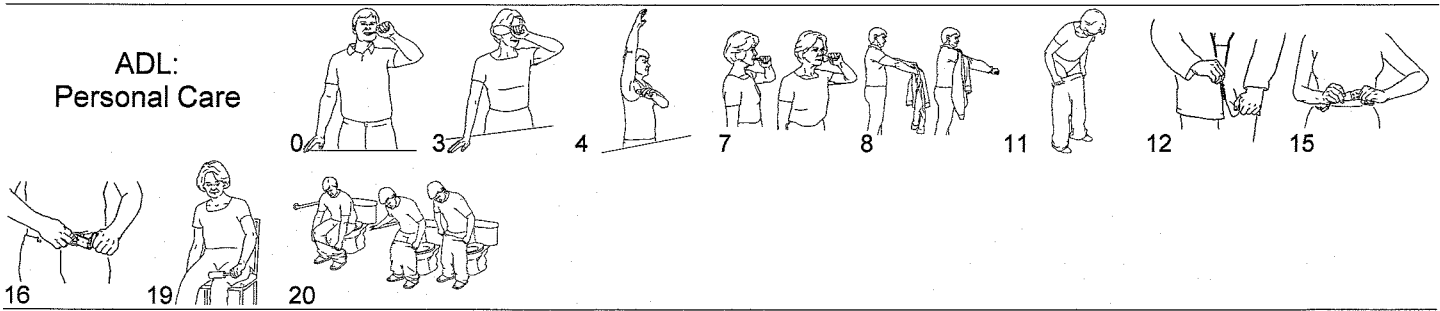

ADL: Eating

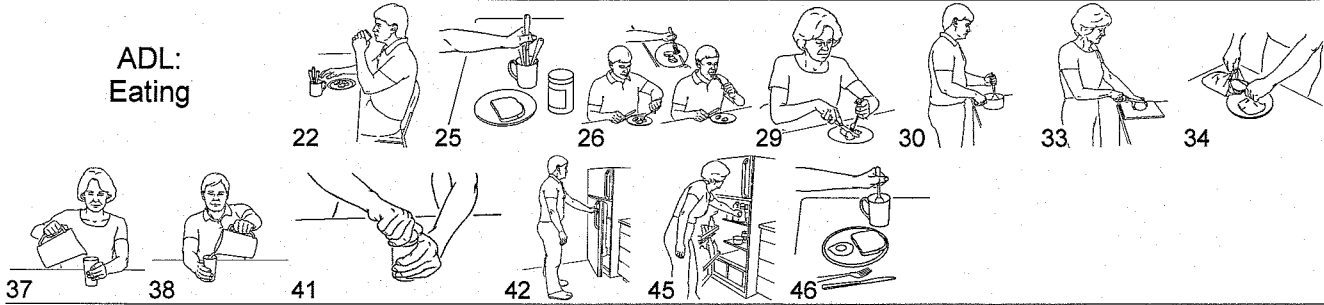

ADL: Household

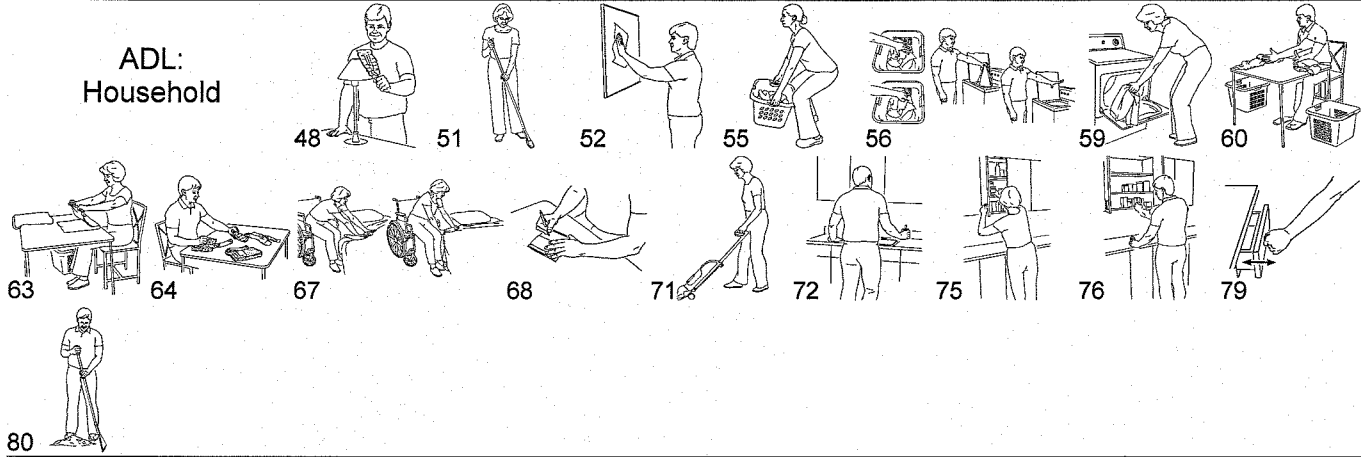

ADL: Recreation

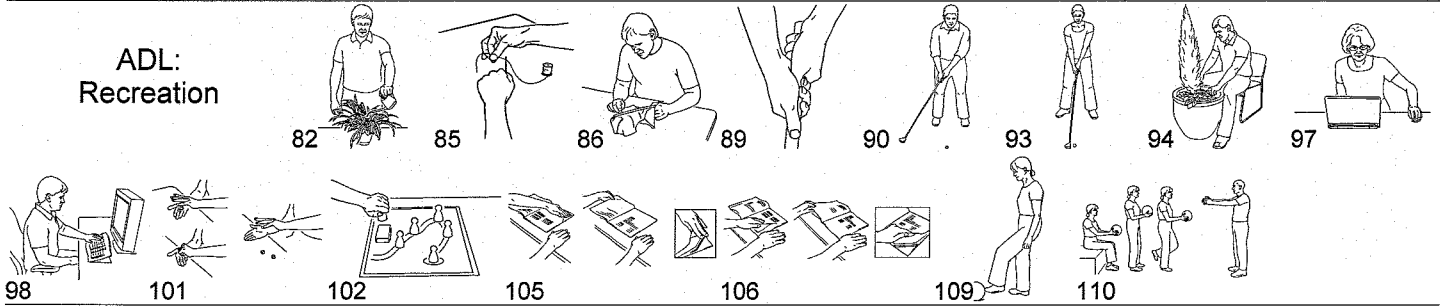

AROM: Neck

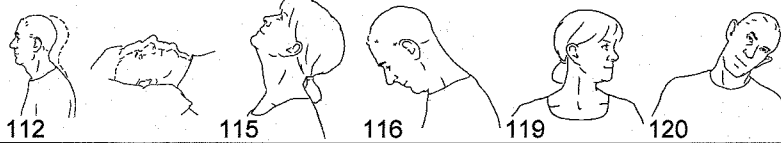

AROM: Shoulder

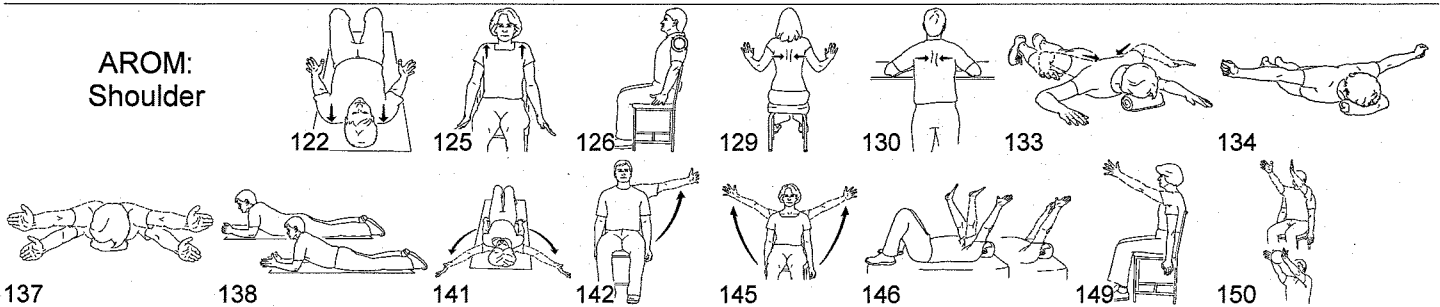

Neurological Rehabilitation Kit

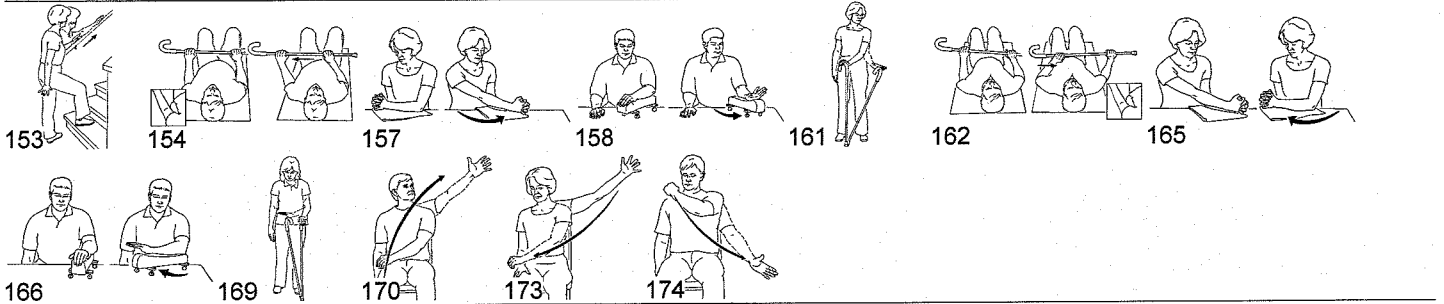

AROM: Elbow

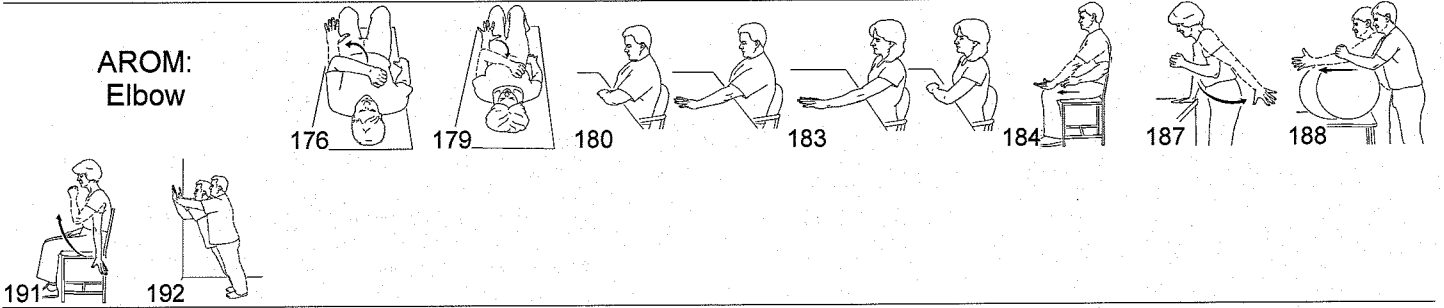

AROM: Wrist

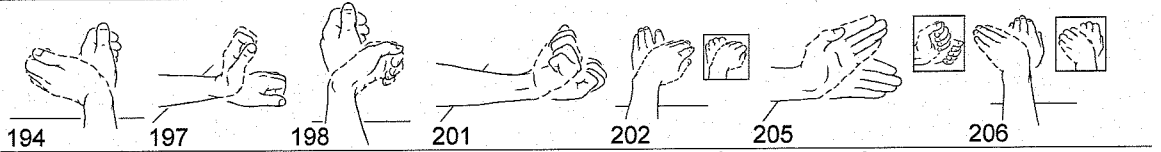

AROM: Finger

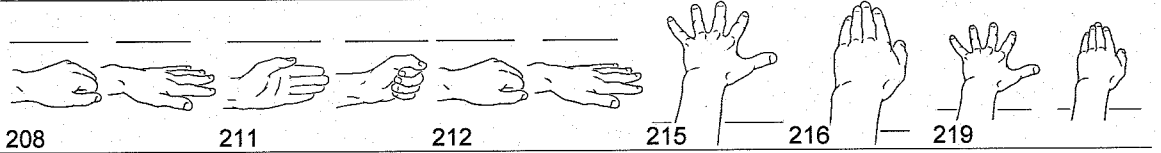

AROM: Trunk



AROM: Hip

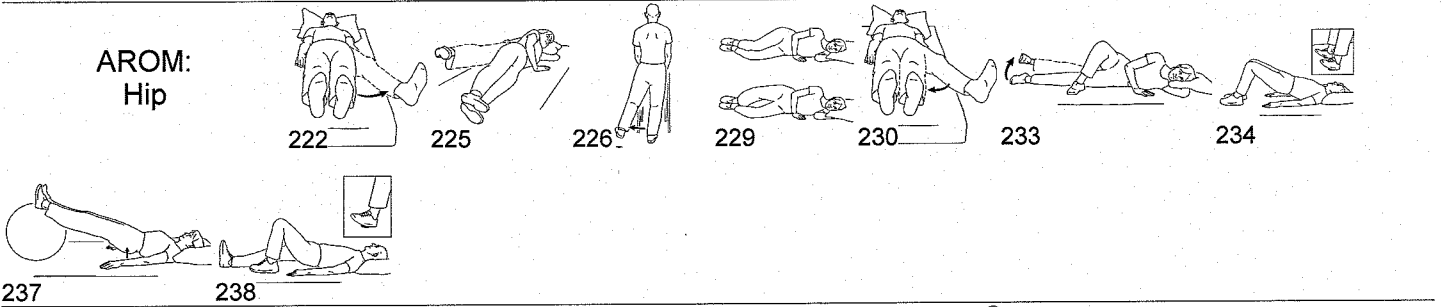

AROM: Hip / Knee

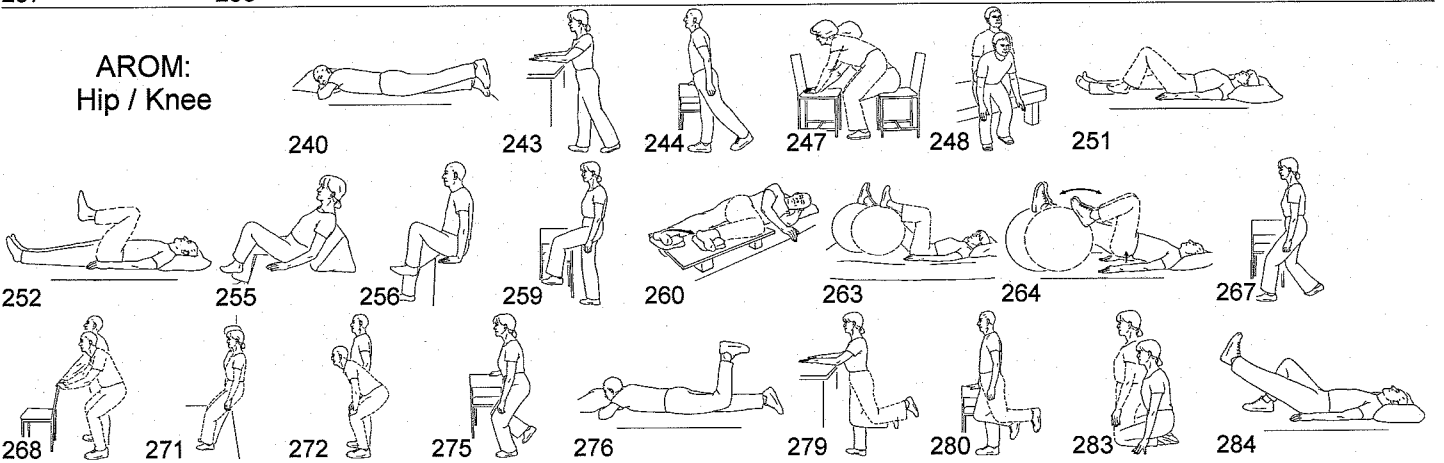

Neurological Rehabilitation Kit

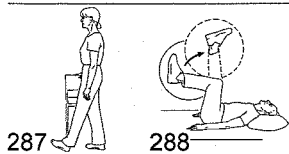

AROM: Knee

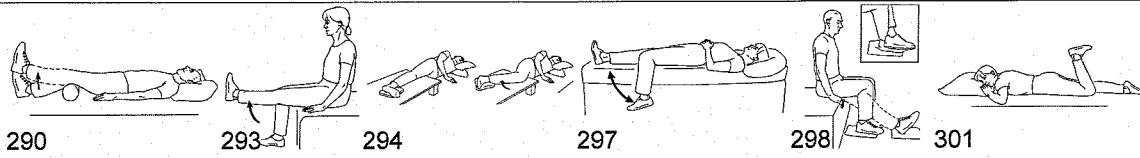

AROM: Ankle

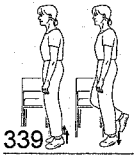
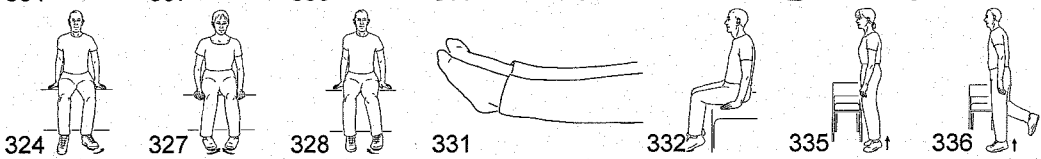
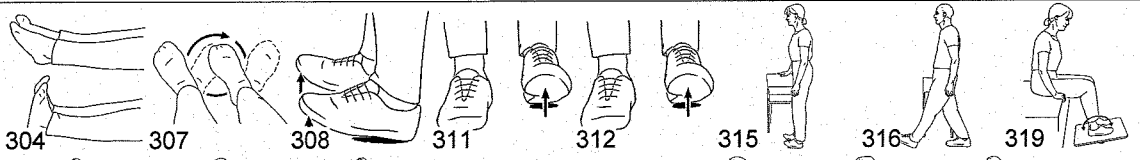

Assisted: Caregiver Body Mechanics Tips

No Picture 340
No Picture 343

Assisted: Caregiver Assisted

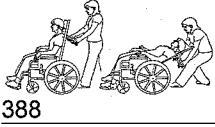
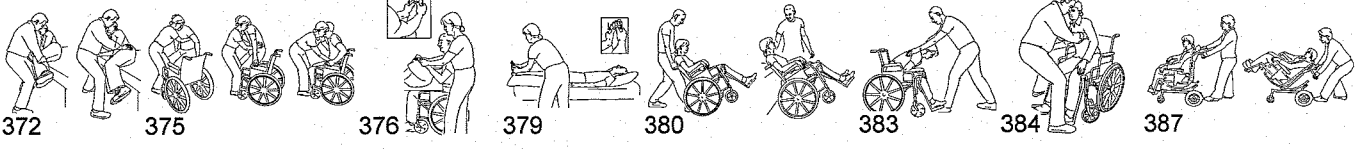
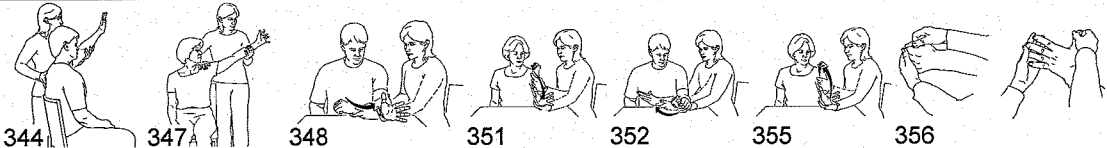

Assisted: Self Assisted

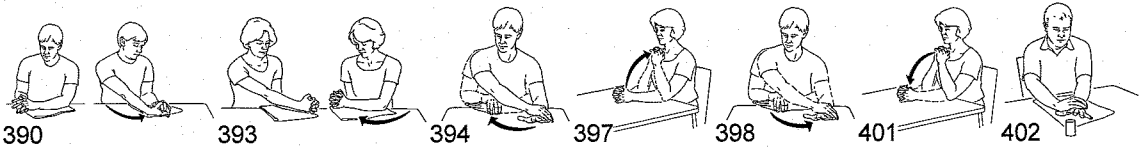

Neurological Rehabilitation Kit



405 406

Assisted: Self Assisted With Object

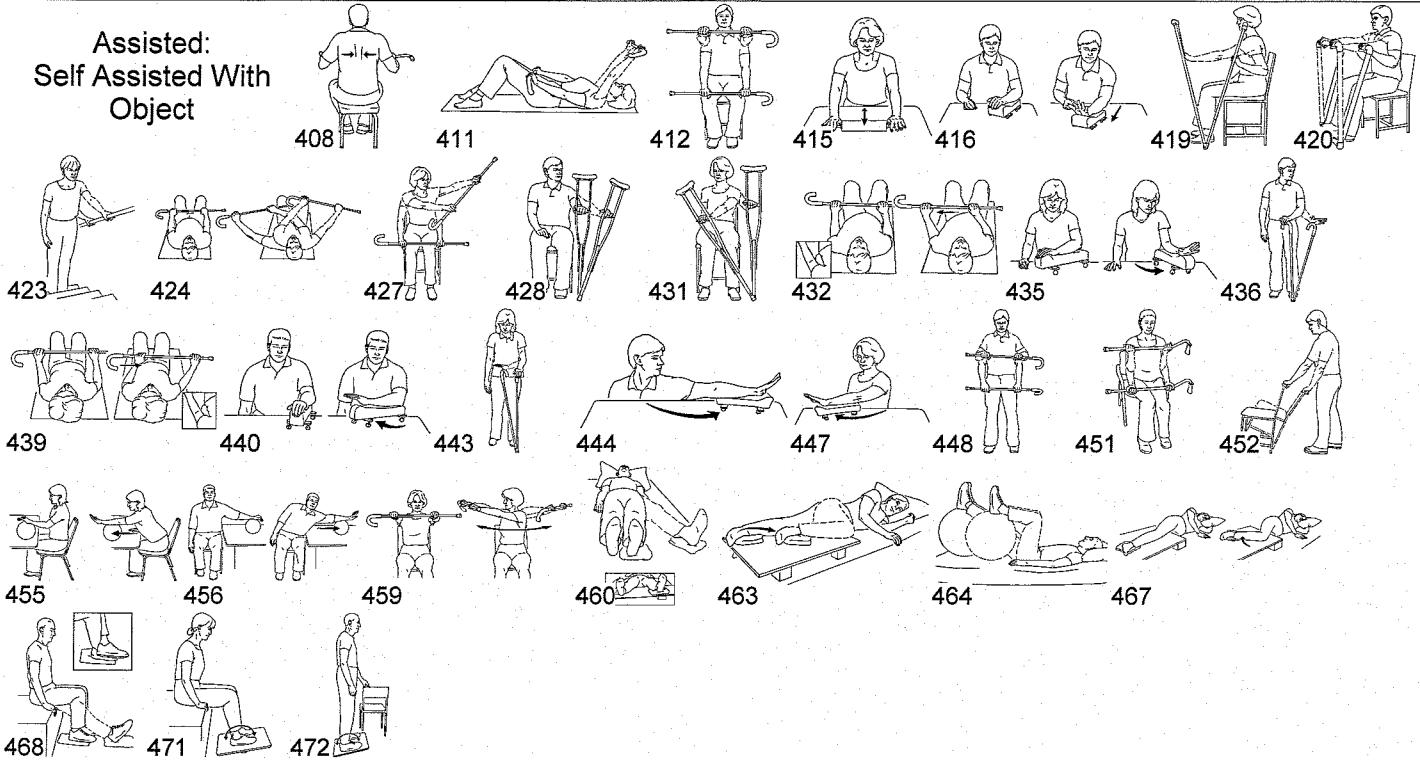

Balance: Bilateral Stance

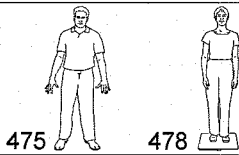

475 478

Balance: Single Limb Stance



479

Balance: Functional Mobility

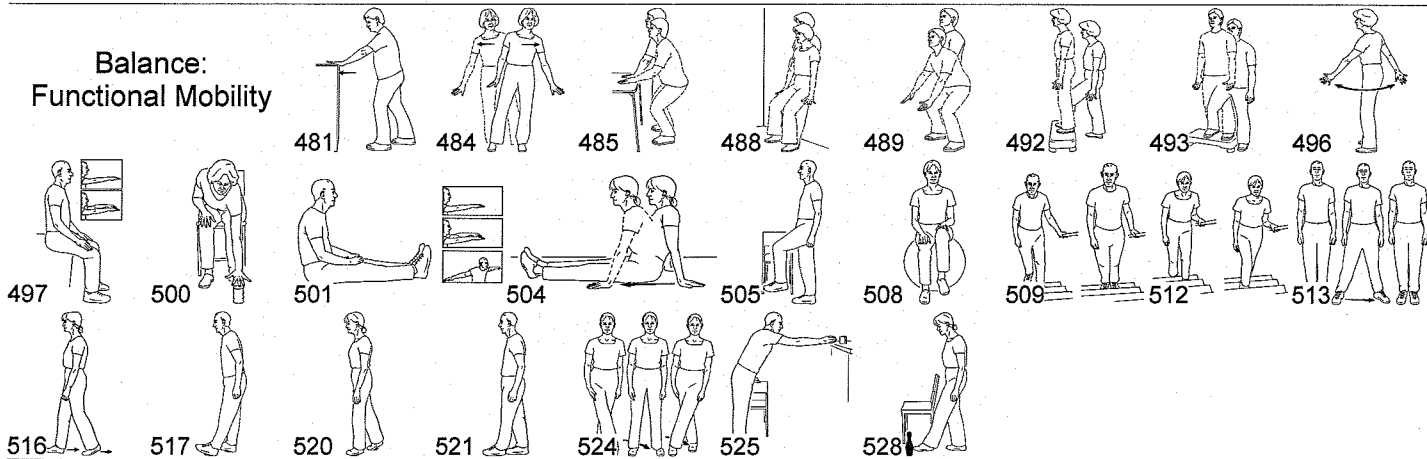

Exercise Progression Tips

No
Picture

1247

Neurological Rehabilitation Kit

Functional Mobility: Bed Mobility

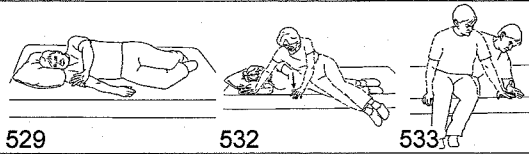

529

532

533

Functional Mobility: Transfer

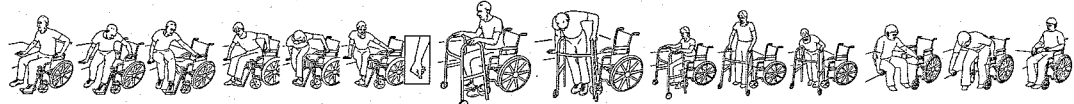

535

538

539

542

543

Functional Mobility: Developmental Positions

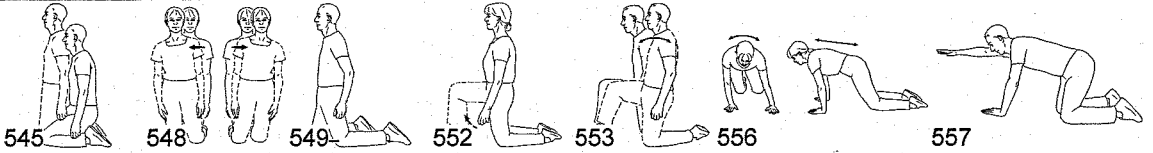

545

548

549

552

553

556

557

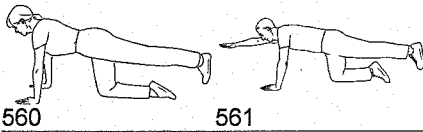

560

561

Functional Mobility: Sit to Stand

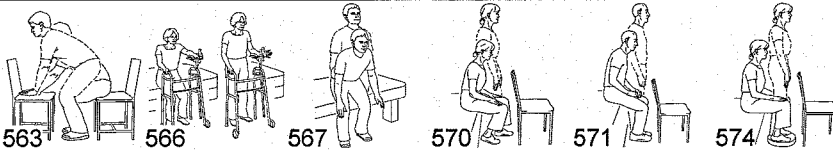

563

566

567

570

571

574

Functional Mobility: Pre Gait

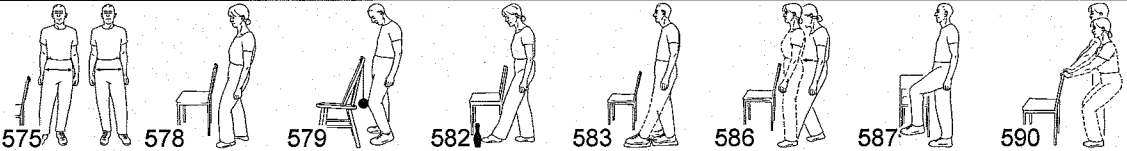

575

578

579

582

583

586

587

590

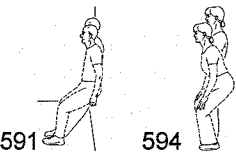

591

594



595

Functional Mobility: Ambulation

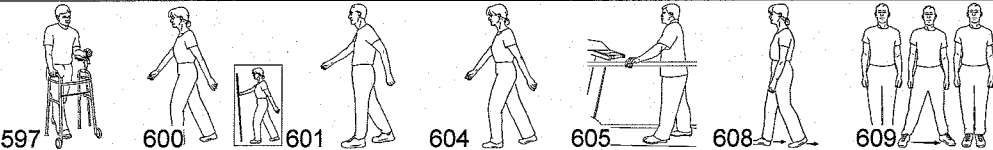

597

600

601

604

605

608

609

Functional Mobility: Stairs

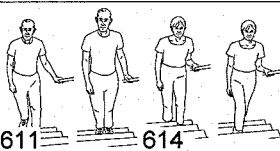

611

614

Functional Mobility: Pressure Relief

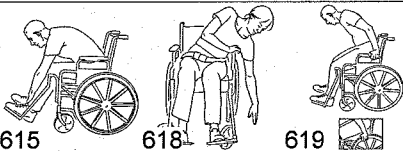

615

618

619

Functional Mobility: Other

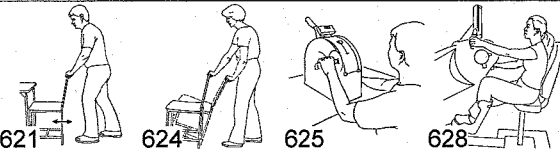

621

624

625

628

Grasp / Release: Functional Activities

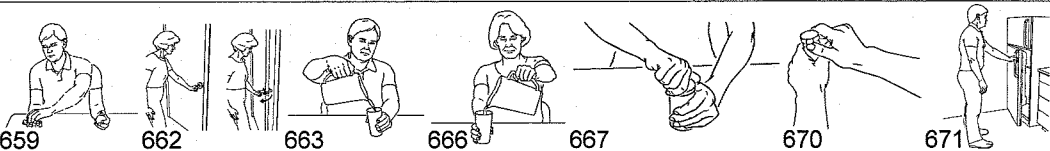

659

662

663

666

667

670

671

Neurological Rehabilitation Kit

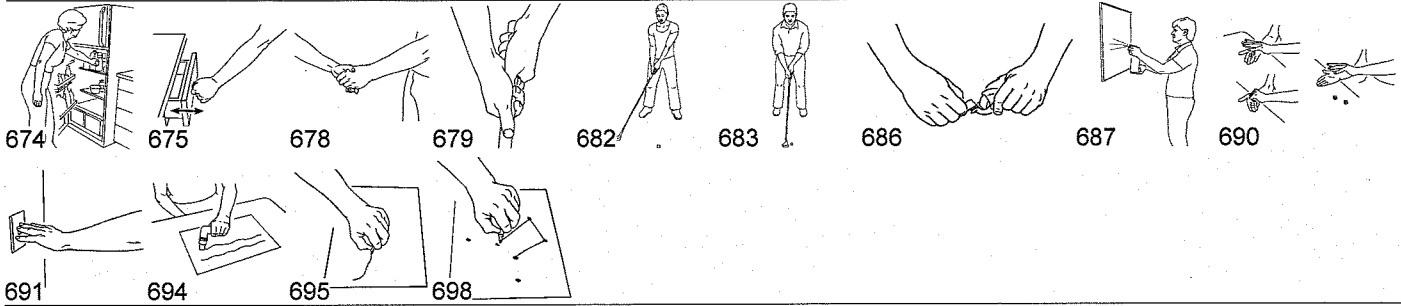

Grasp / Release: Pinch / Key Grip

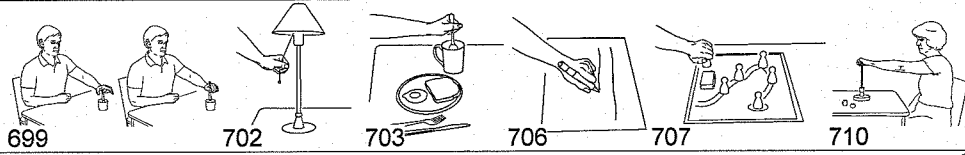

Grasp / Release: Other

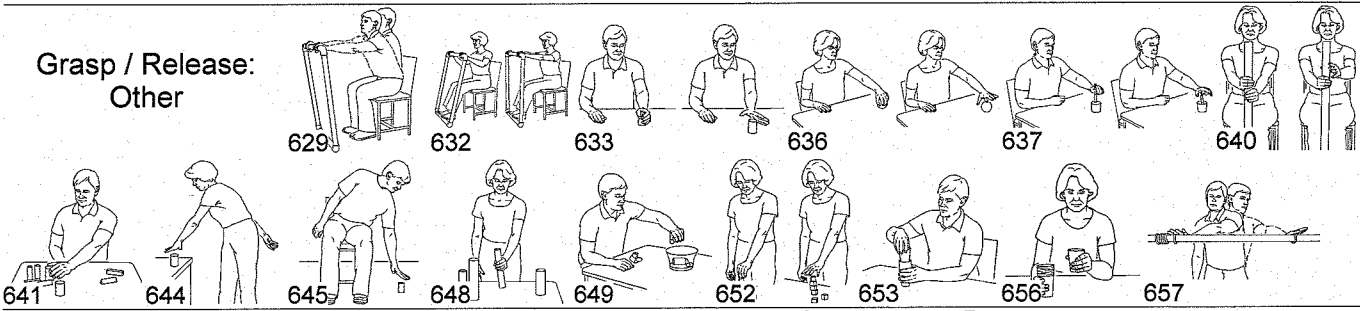

Positioning



Reaching / Targeting

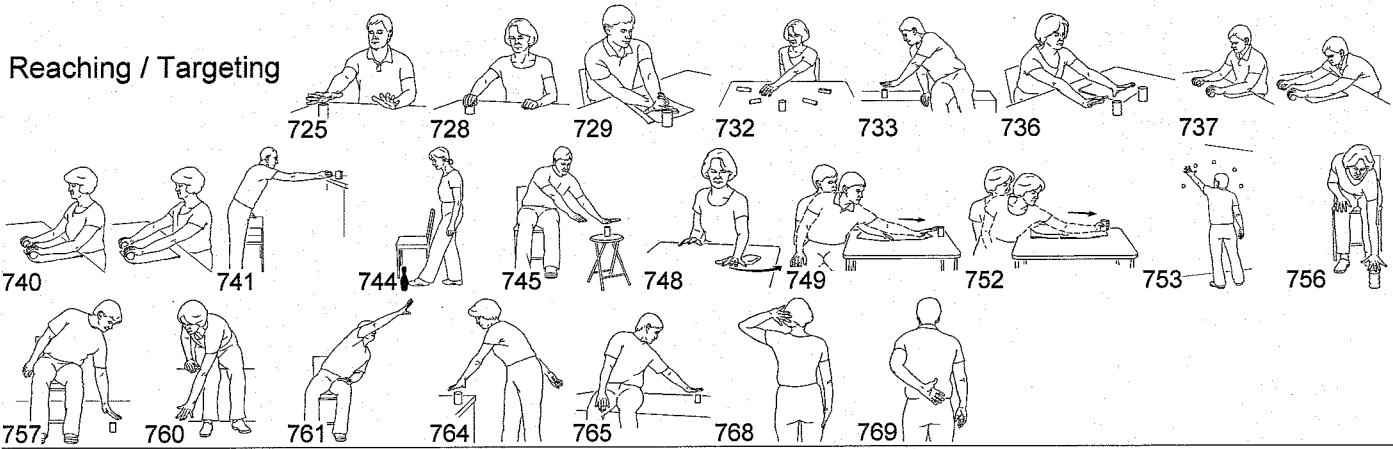

Safety Tips

No Picture
1248

Sensory Motor: Upper Extremity

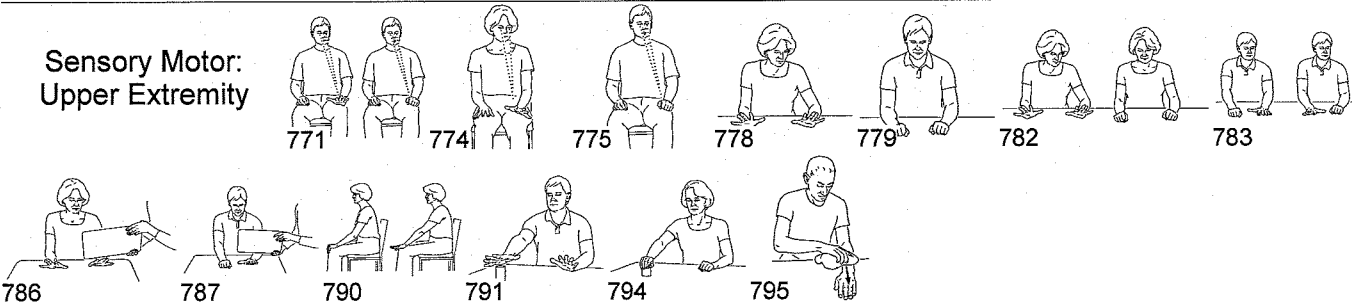

Neurological Rehabilitation Kit

Sensory Motor: Lower Extremity

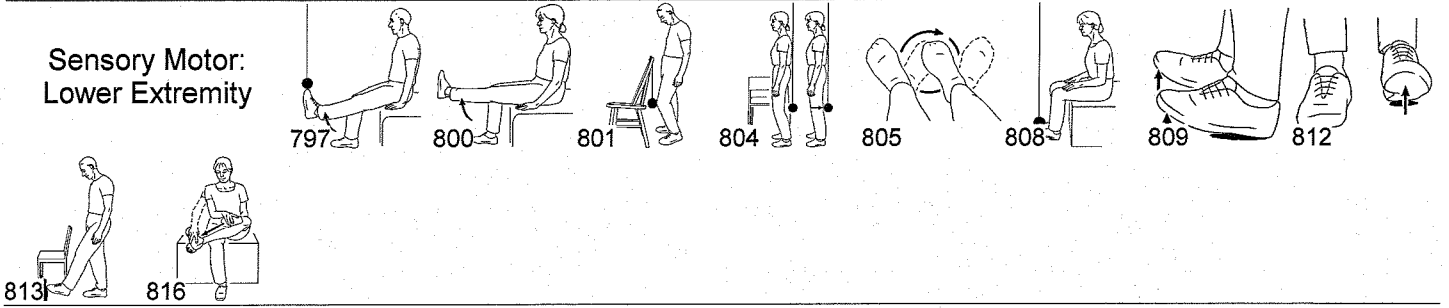

Stance Variations

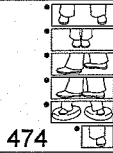

Strengthening: Scapula

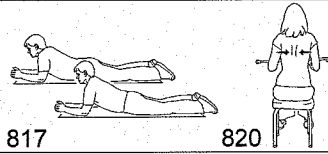

Strengthening: Shoulder

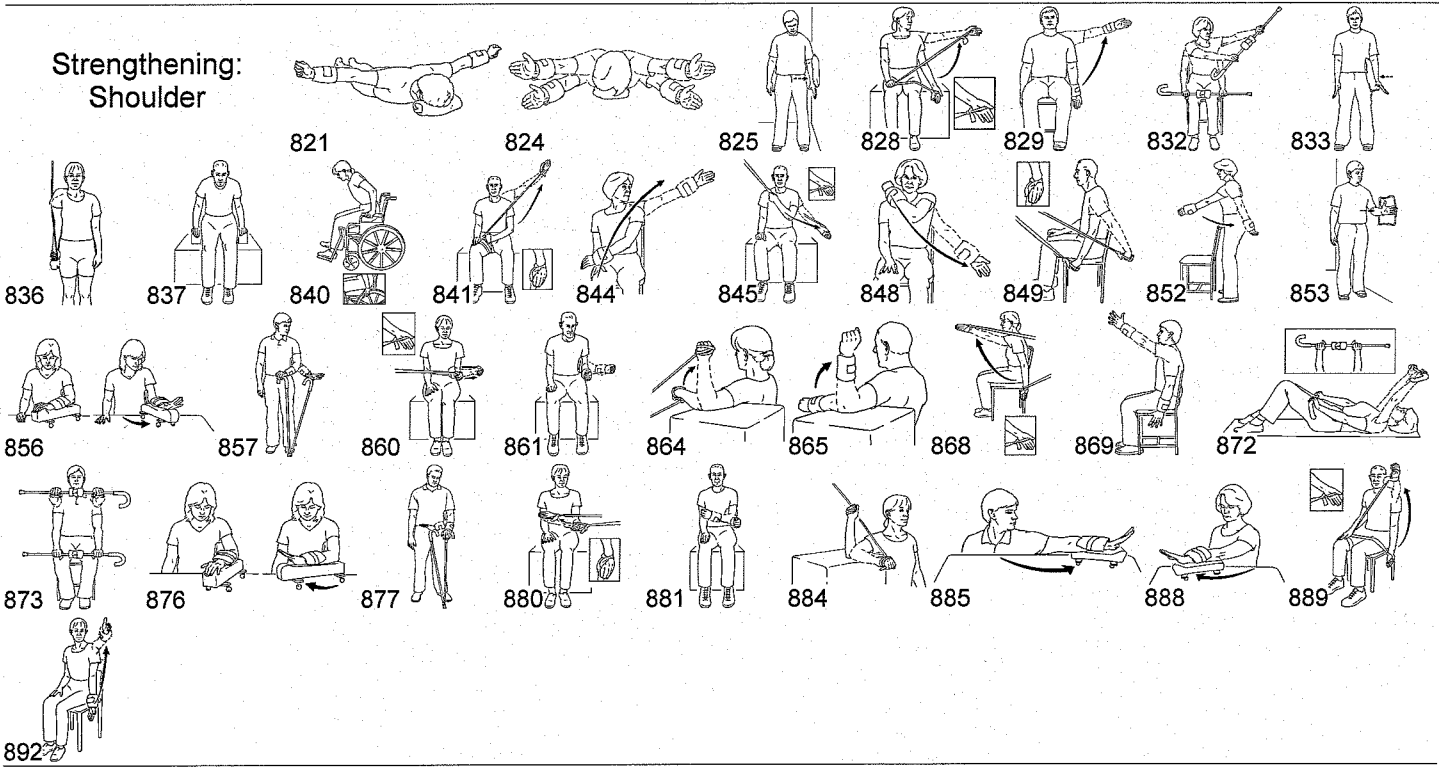

Strengthening: Elbow

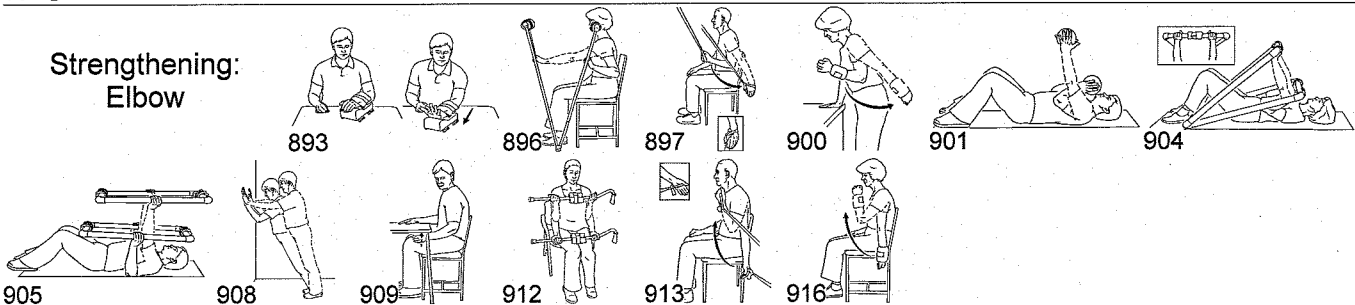

Strengthening: Wrist

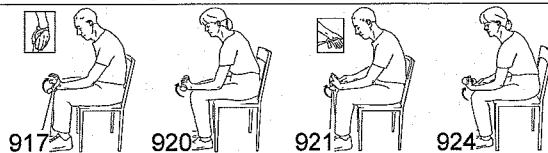

Neurological Rehabilitation Kit

Strengthening: Fingers

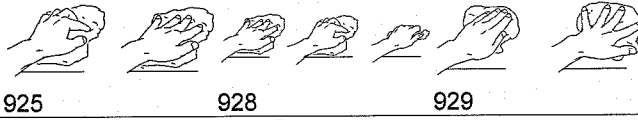

Strengthening: Trunk

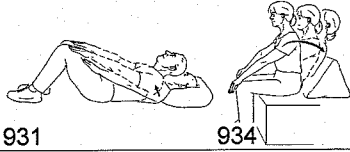

Strengthening: Hip

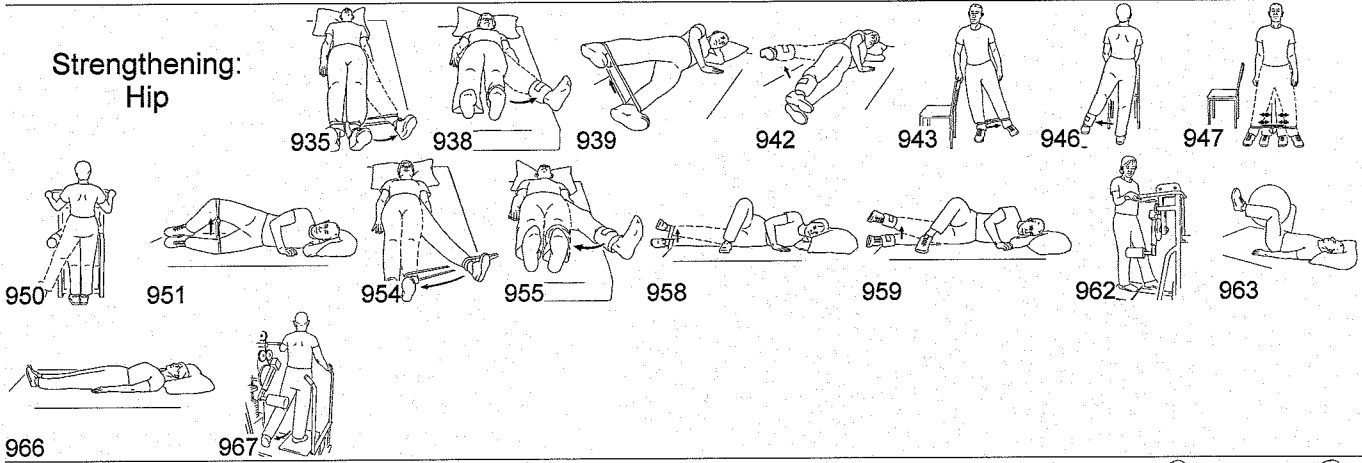

Strengthening: Hip / Knee

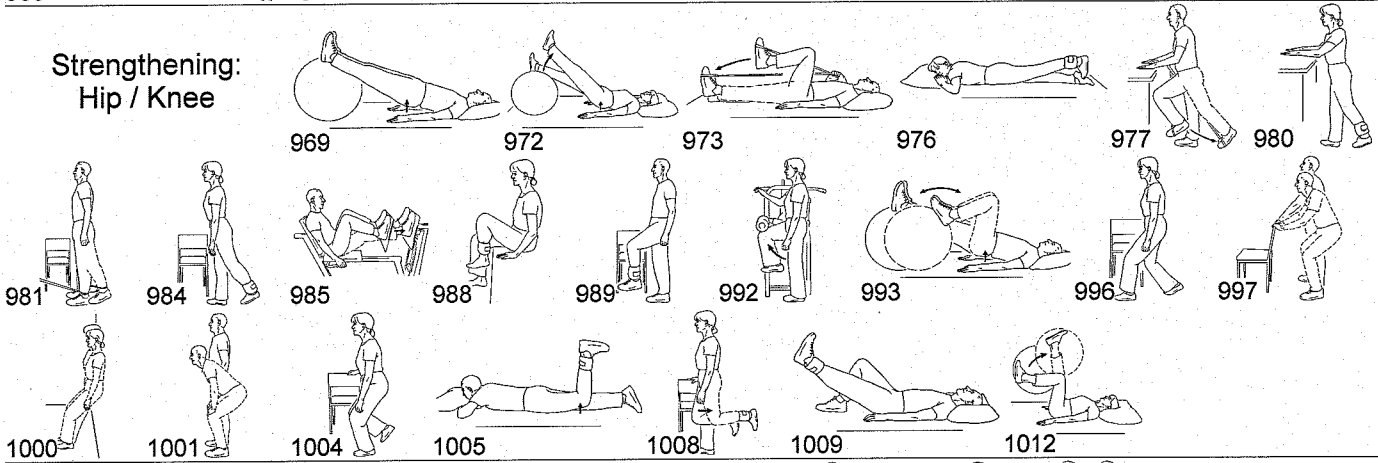

Strengthening: Knee

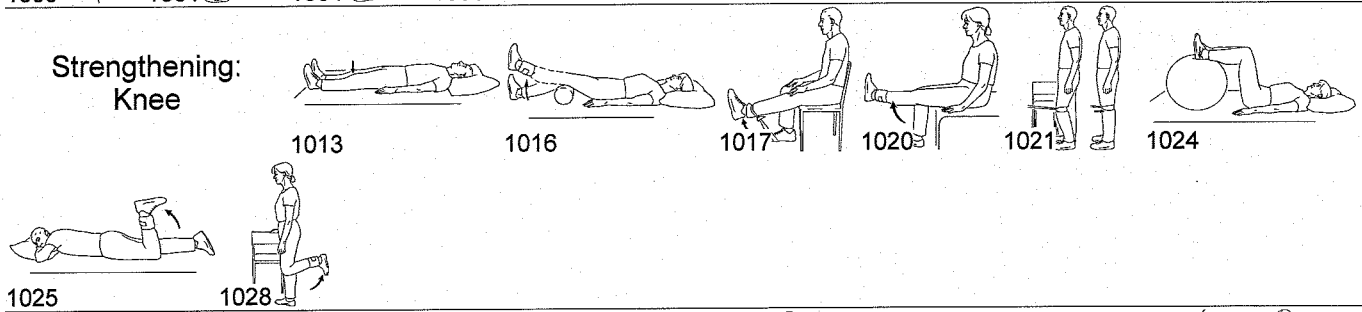

Strengthening: Ankle

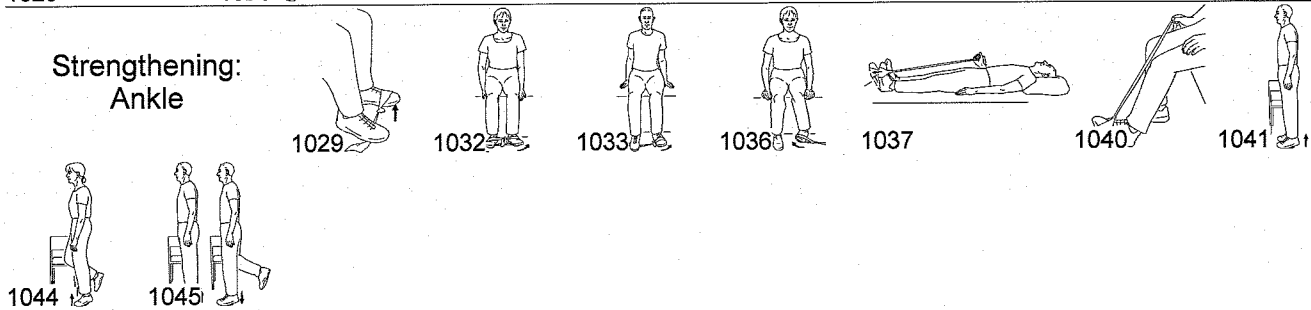

Neurological Rehabilitation Kit

Stretching:
Chest

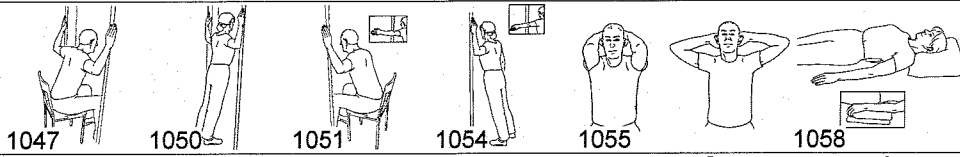

Stretching:
Shoulder

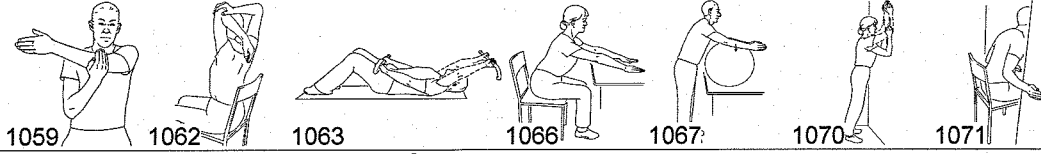

Stretching:
Elbow

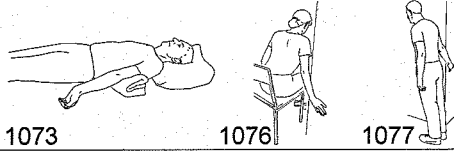

Stretching:
Wrist

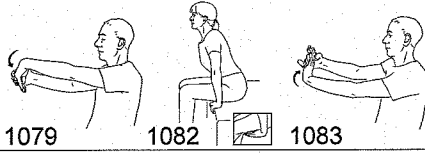

Stretching:
Fingers

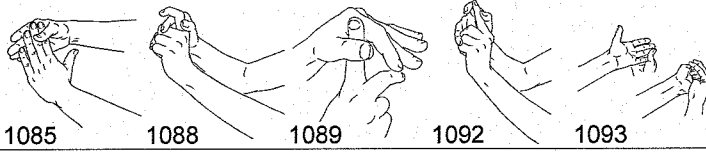

Stretching:
Trunk



Stretching:
Hip

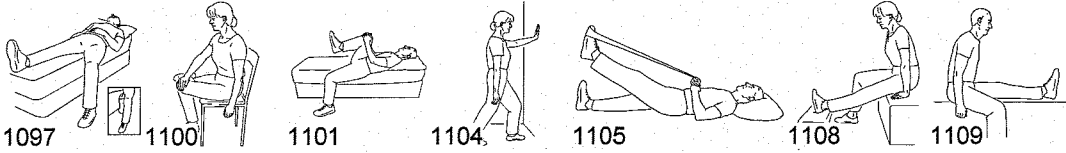

Stretching:
Knee

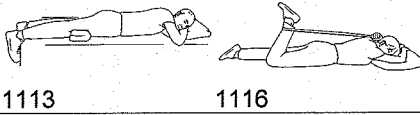

Stretching:
Ankle

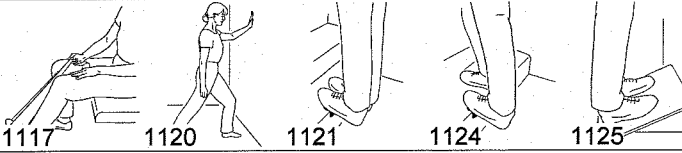

Stretching:
Toes

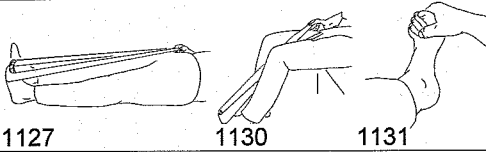

Stretching:
Caregiver Assisted

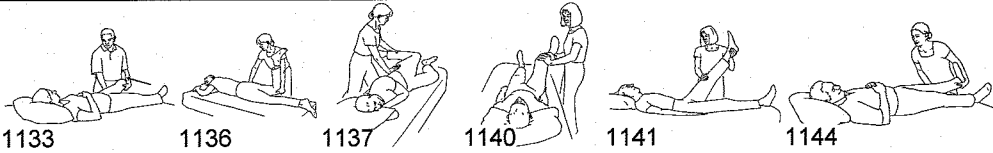

Neurological Rehabilitation Kit

Stretching: SCI Self Stretch

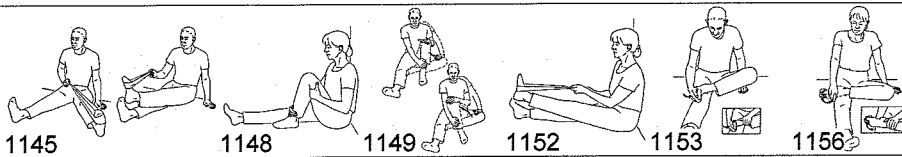

Trunk Activation: Pelvic Tilt

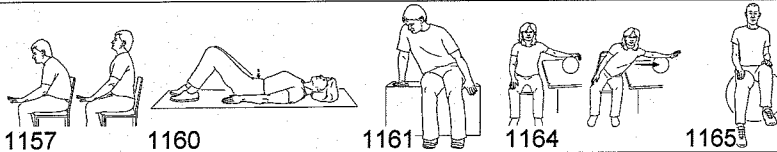

Trunk Activation: Supine

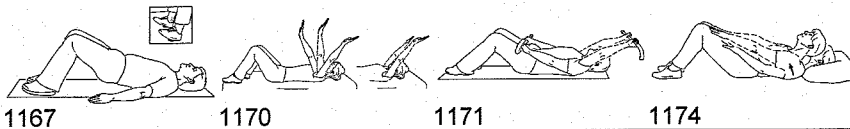

Trunk Activation: Forward Lean

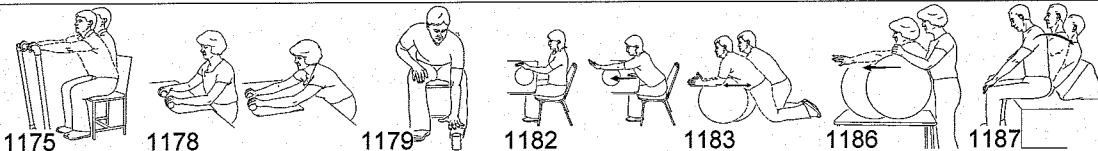

Trunk Activation: Rotation

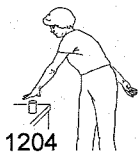
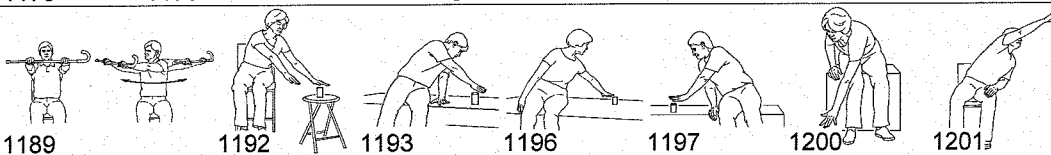

Trunk Activation: Side Bend

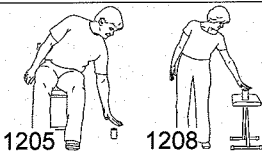

UE Weight Bearing: Sitting

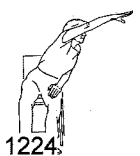
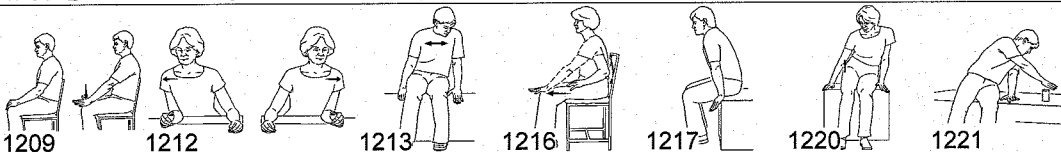

UE Weight Bearing: Standing

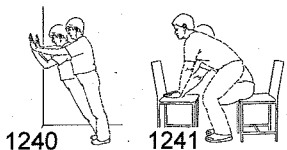
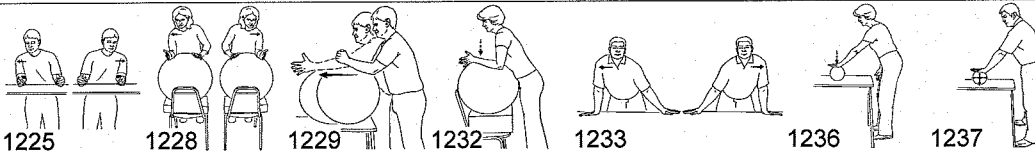

UE Weight Bearing: Other

